

Meeting the industry's needs: Advances in generation of trace level HCl gas reference materials

Yoana Hristova, Michael Ward, Ruth Pearce and David Worton
National Physical Laboratory, UK; **Contact:** yoana.hristova@npl.co.uk

WHAT ARE AIRBORNE MOLECULAR CONTAMINANTS (AMCs)



COST OF CORROSION

Industries **plagued** by corrosion

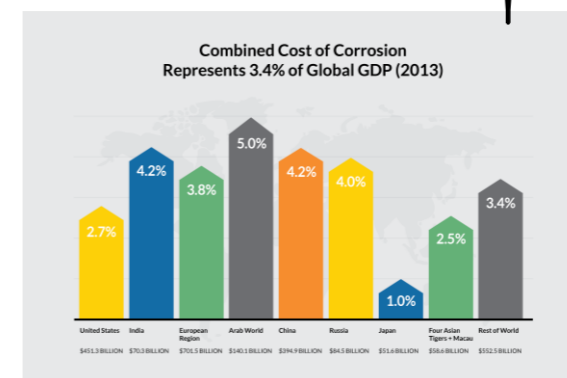
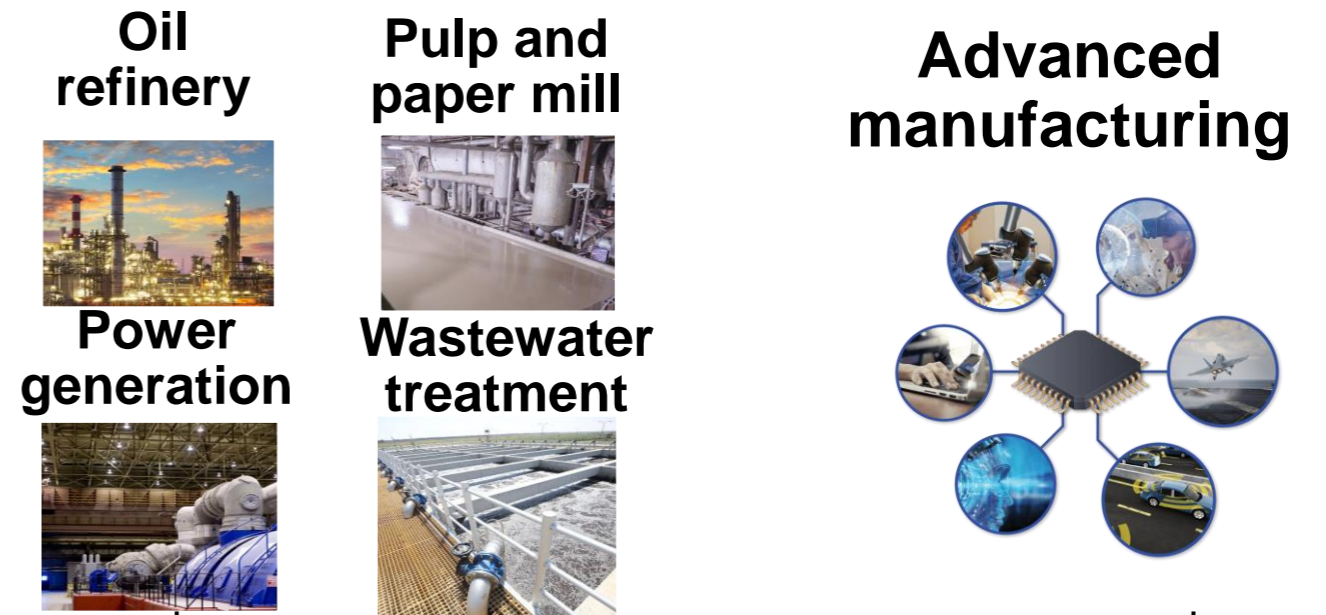

*cost does not include individual safety or environmental consequences.

Monitoring of AMCs required at 1-10 nmol mol⁻¹ level => **need for traceable PRMs.**

CONVENTIONAL VS NOVEL PREPARATION METHODS

HCl is very reactive => huge adsorption losses. Limiting factor in advancing the science.

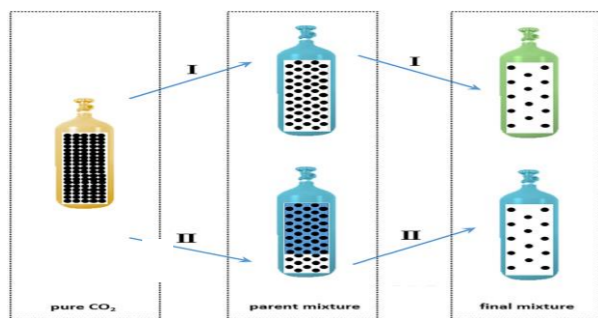
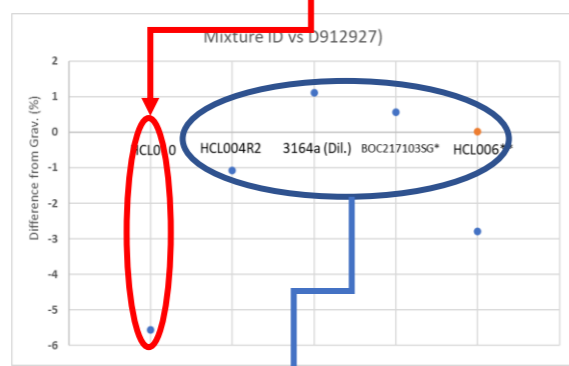
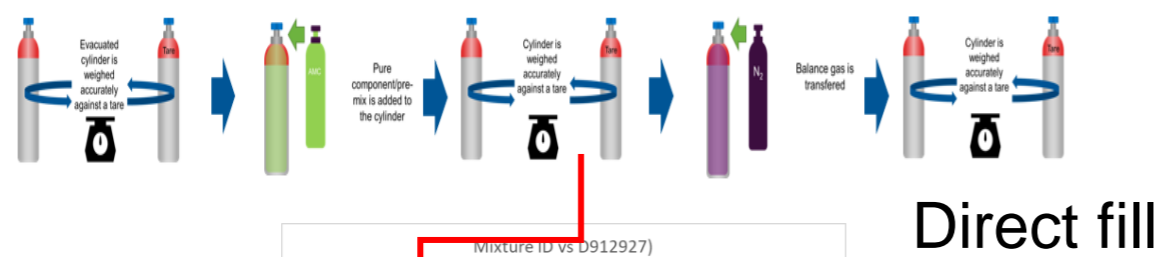

Brewer et al. Anal. Chem. 2019, 91, 5310-5315

ADVANCES IN TRACE LEVELS HCl GENERATION

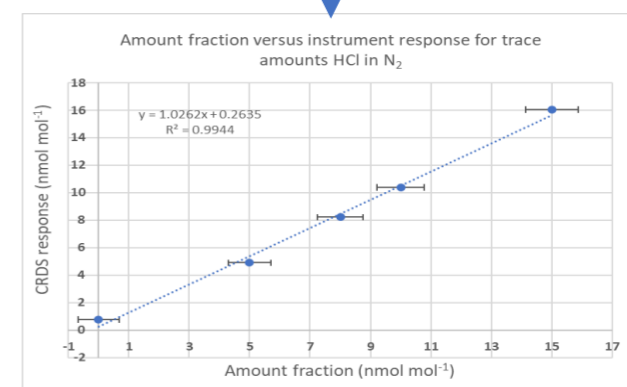
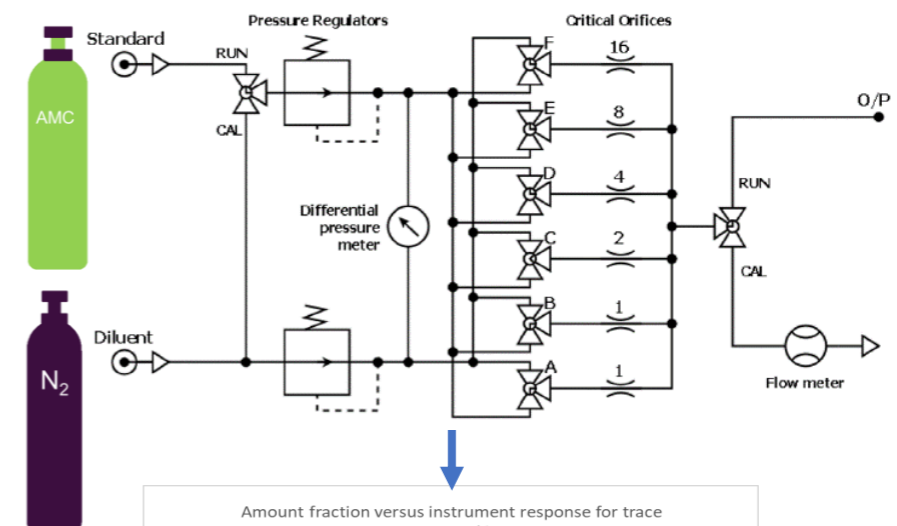

*NPL is the *only* NMI to achieve stable amount fractions in the 1-10 nmol mol⁻¹ range required by the industry.

Brewer et al. Meas. Sci. Technol. 2010, 21, 115902

OUTCOMES AND FUTURE WORK

- NPL innovation method – exchange dilution, offers minimal adsorption preparative losses.
- Novel dynamic dilution system developed allows for generation of **trace levels AMCs including HCl** in the 1-10 nmol mol⁻¹ range required for meeting the industry's needs.
- Future works requires participation in international intercomparison for achieving traceability.
- SI traceable HCl mixtures with reduced uncertainty (<3% k=2) can be offered to stakeholders.